

CAFE



OFFICE



STORE



SHOWROOM



BAR



NewLux 48V Track

Installationsanleitung





1. Freischalten
2. Gegen Wiedereinschalten sichern
3. Spannungsfreiheit feststellen
4. Erden und kurzschließen
5. Benachbarte, unter Spannung stehende Teile abdecken oder abschränken

On/Off

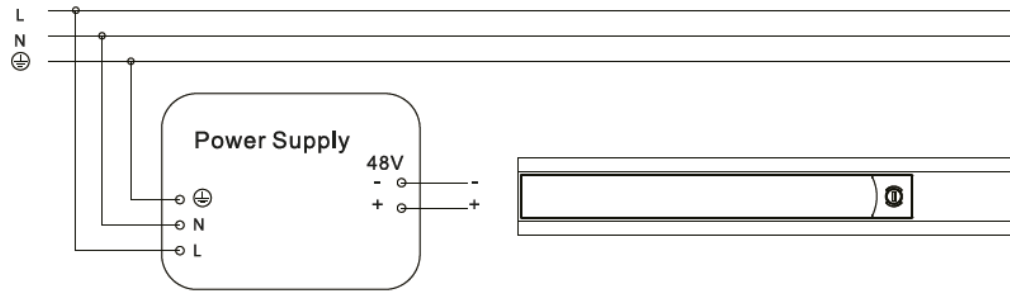

Dali

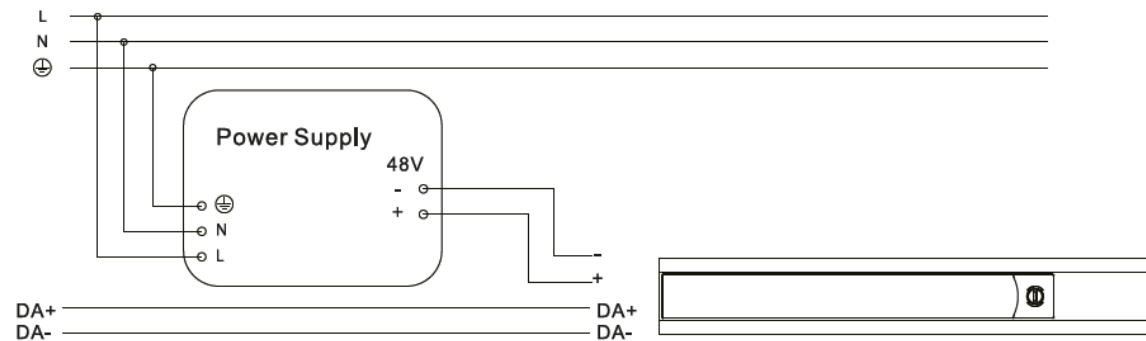

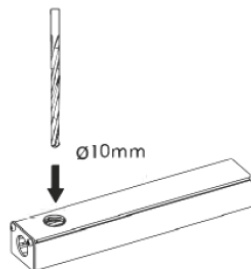
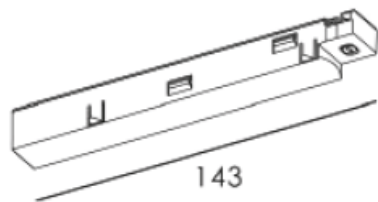
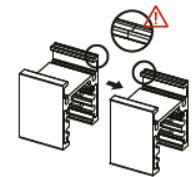
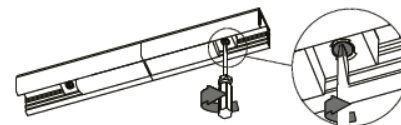
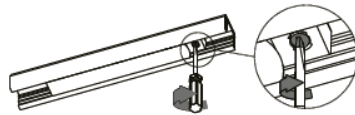
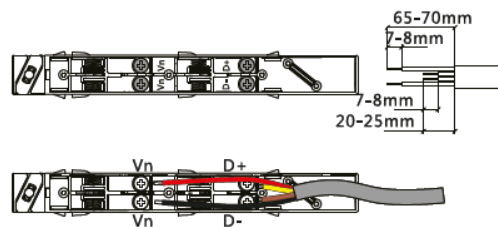
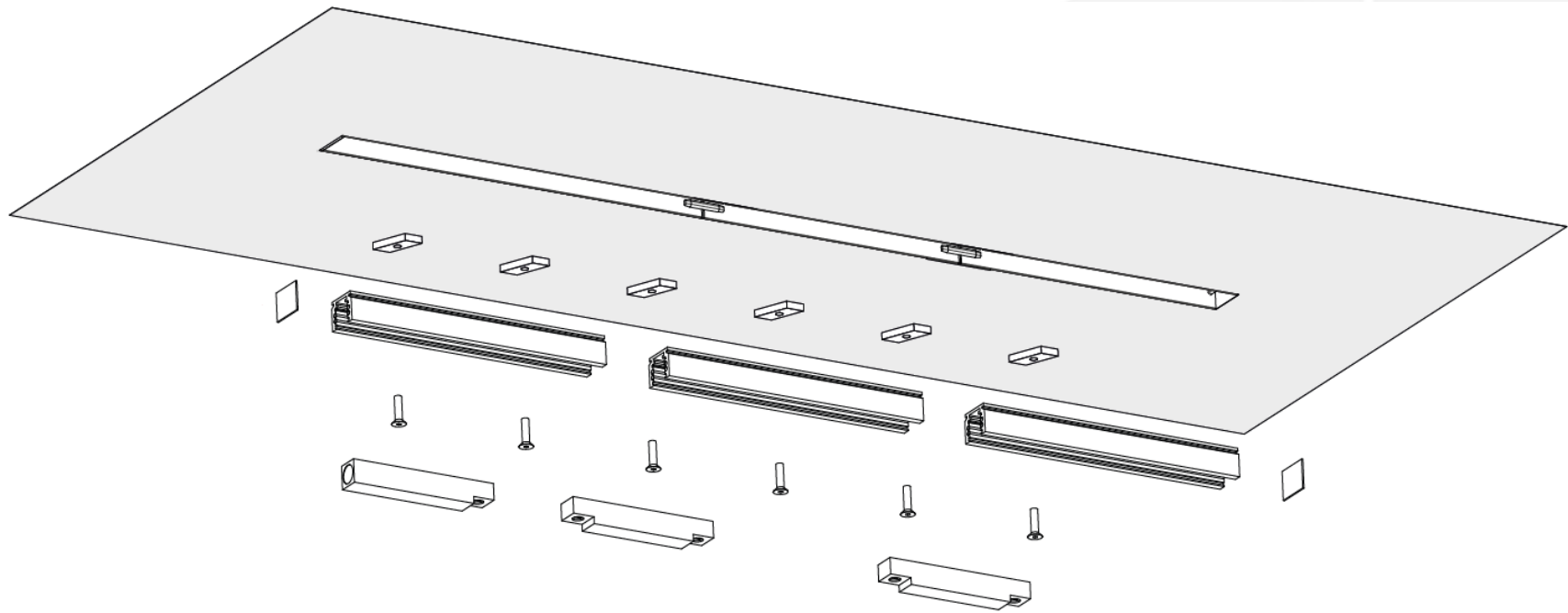

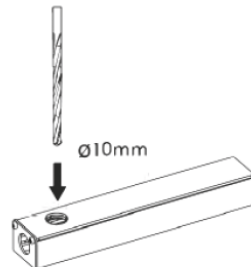
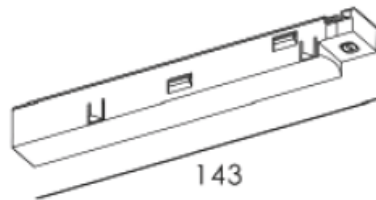
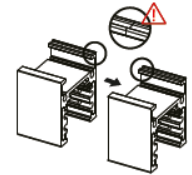
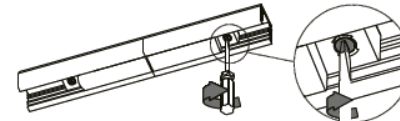
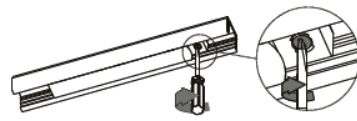
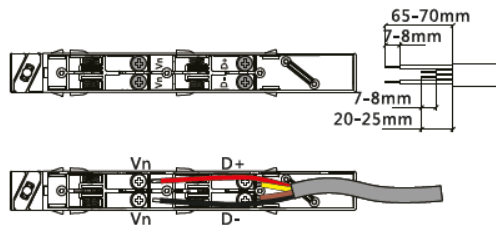
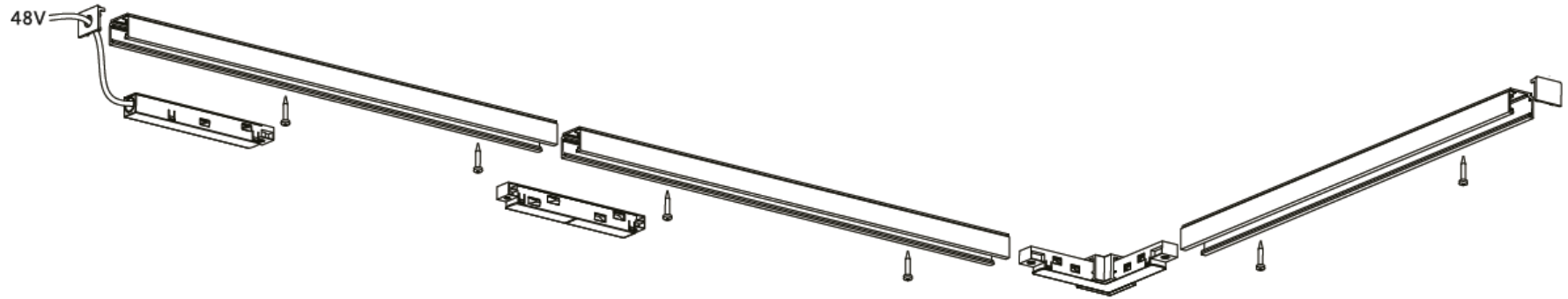
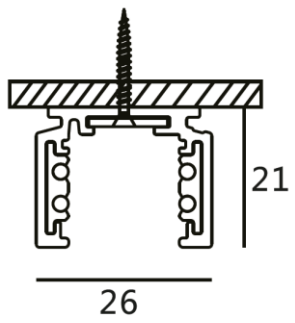

NewLux 48V Track – AP Montage

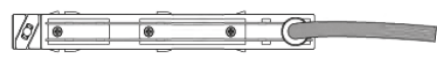
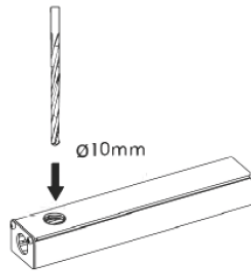
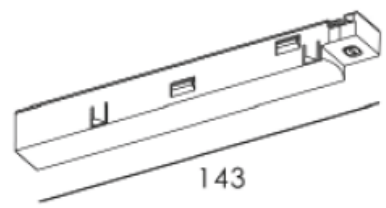
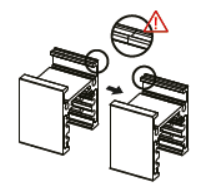
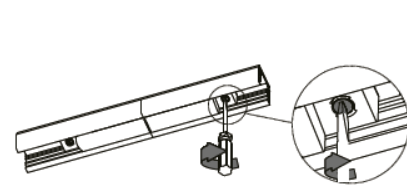
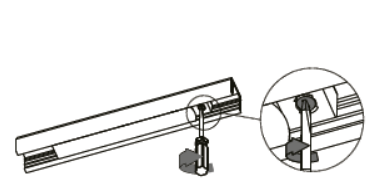
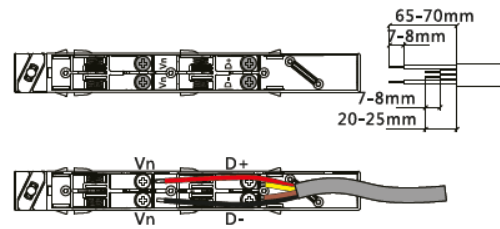
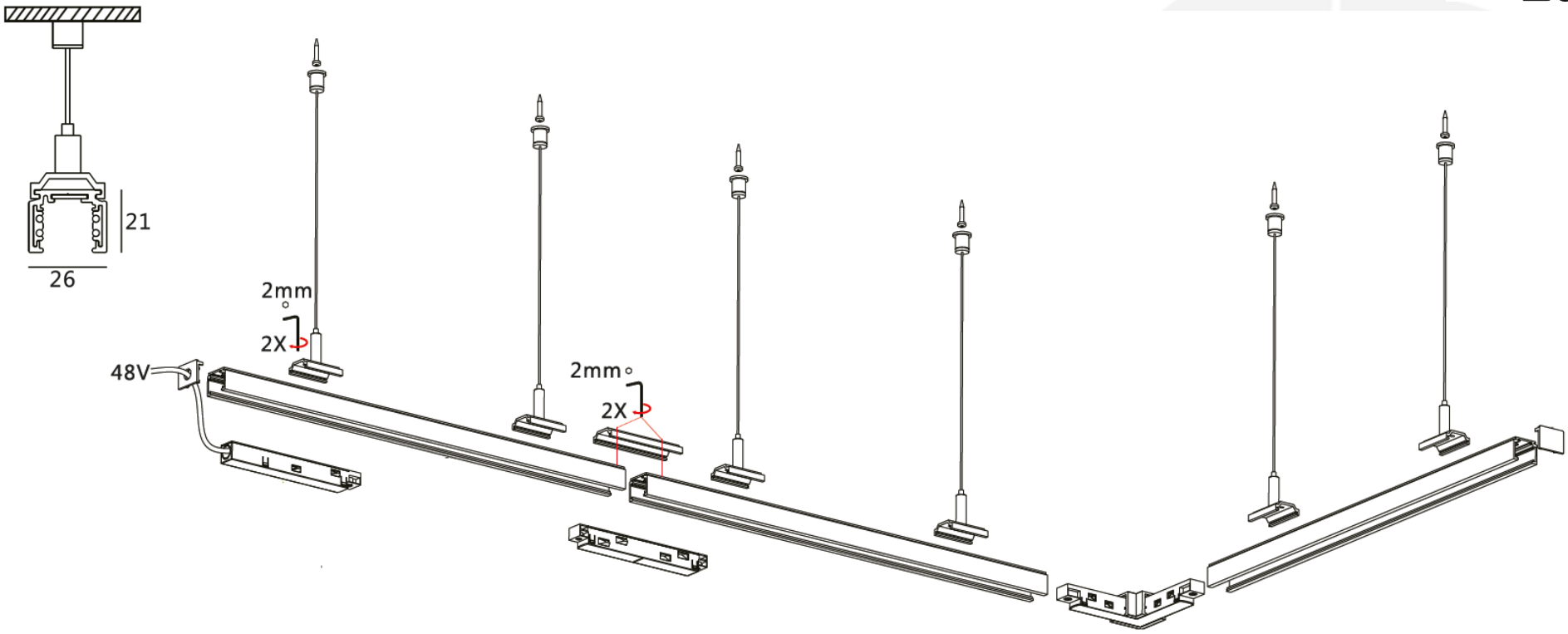

NewLux 48V Track – Abgehängte Montage

